



## N-Channel Logic Level Enhancement Mode Field Effect Transistor

### PRODUCT SUMMARY

V <sub>DSS</sub>	I <sub>D</sub>	R <sub>DS(ON)</sub> (mΩ) Typ
100V	2A	400 @ V <sub>GS</sub> =10V
		480 @ V <sub>GS</sub> =4.5V

### FEATURES

- Super high dense cell design for low R<sub>DS(ON)</sub>.
- Rugged and reliable.
- Surface Mount Package.

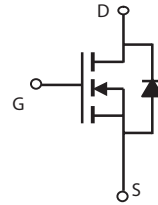
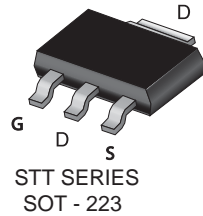

### ABSOLUTE MAXIMUM RATINGS (T<sub>A</sub>=25°C unless otherwise noted)

Symbol	Parameter	Limit	Units
V <sub>DS</sub>	Drain-Source Voltage	100	V
V <sub>GS</sub>	Gate-Source Voltage	±20	V
I <sub>D</sub>	Drain Current-Continuous <sup>a c</sup>	T <sub>A</sub> =25°C	2
		T <sub>A</sub> =70°C	1.6
I <sub>DM</sub>	-Pulsed <sup>c</sup>	13	A
E <sub>AS</sub>	Single Pulse Avalanche Energy <sup>d</sup>	3	mJ
P <sub>D</sub>	Maximum Power Dissipation <sup>a</sup>	T <sub>A</sub> =25°C	3
		T <sub>A</sub> =70°C	1.9
T <sub>J</sub> , T <sub>STG</sub>	Operating Junction and Storage Temperature Range	-55 to 150	°C

### THERMAL CHARACTERISTICS

R <sub>θJA</sub>	Thermal Resistance, Junction-to-Ambient <sup>a</sup>	42	°C/W
------------------	--	----	------

# STT02N10

Ver 1.0

## ELECTRICAL CHARACTERISTICS (T<sub>A</sub>=25°C unless otherwise noted)

Symbol	Parameter	Conditions	Min	Typ	Max	Units
<b>OFF CHARACTERISTICS</b>						
BV <sub>DSS</sub>	Drain-Source Breakdown Voltage	V <sub>GS</sub> =0V, I <sub>D</sub> =250uA	100			V
I <sub>DSS</sub>	Zero Gate Voltage Drain Current	V <sub>DS</sub> =80V, V <sub>GS</sub> =0V			1	uA
I <sub>GSS</sub>	Gate-Body Leakage Current	V <sub>GS</sub> = ±20V, V <sub>DS</sub> =0V			±100	nA
<b>ON CHARACTERISTICS</b>						
V <sub>GS(th)</sub>	Gate Threshold Voltage	V <sub>DS</sub> =V <sub>GS</sub> , I <sub>D</sub> =250uA	1	2.3	3	V
R <sub>DS(ON)</sub>	Drain-Source On-State Resistance	V <sub>GS</sub> =10V, I <sub>D</sub> =1A		400	500	m ohm
		V <sub>GS</sub> =4.5V, I <sub>D</sub> =0.8A		480	650	m ohm
g <sub>FS</sub>	Forward Transconductance	V <sub>DS</sub> =10V, I <sub>D</sub> =1A		2.8		S
<b>DYNAMIC CHARACTERISTICS<sup>b</sup></b>						
C <sub>ISS</sub>	Input Capacitance	V <sub>DS</sub> =25V, V <sub>GS</sub> =0V f=1.0MHz		169		pF
C <sub>OSS</sub>	Output Capacitance			24		pF
C <sub>RSS</sub>	Reverse Transfer Capacitance			14		pF
<b>SWITCHING CHARACTERISTICS<sup>b</sup></b>						
t <sub>D(ON)</sub>	Turn-On Delay Time	V <sub>DD</sub> =50V I <sub>D</sub> =1A V <sub>GS</sub> =10V R <sub>GEN</sub> = 6 ohm		6.8		ns
t <sub>r</sub>	Rise Time			9.4		ns
t <sub>D(OFF)</sub>	Turn-Off Delay Time			12.7		ns
t <sub>f</sub>	Fall Time			2		ns
Q <sub>g</sub>	Total Gate Charge		V <sub>DS</sub> =50V, I <sub>D</sub> =1A, V <sub>GS</sub> =10V		3.3	
		V <sub>DS</sub> =50V, I <sub>D</sub> =1A, V <sub>GS</sub> =4.5V		2		nC
Q <sub>gs</sub>	Gate-Source Charge	V <sub>DS</sub> =50V, I <sub>D</sub> =1A,		0.76		nC
Q <sub>gd</sub>	Gate-Drain Charge	V <sub>GS</sub> =10V		1.1		nC
<b>DRAIN-SOURCE DIODE CHARACTERISTICS AND MAXIMUM RATINGS</b>						
V <sub>SD</sub>	Diode Forward Voltage	V <sub>GS</sub> =0V, I <sub>S</sub> =1A		0.81	1.2	V
<b>Notes</b>						
a.Surface Mounted on FR4 Board of 1 inch <sup>2</sup> , 1oz.						
b.Guaranteed by design, not subject to production testing.						
c.Drain current limited by maximum junction temperature.						
d.Starting T <sub>J</sub> =25°C, L=0.3mH, V <sub>DD</sub> = 50V.(See Figure13)						

May,08,2014

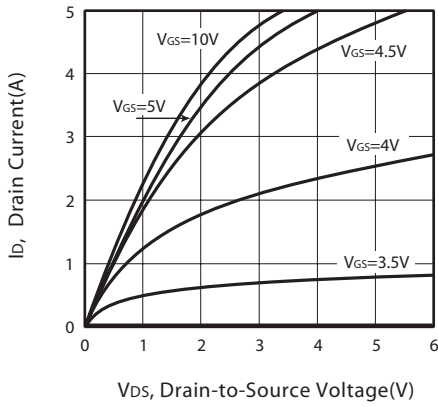

Figure 1. Output Characteristics

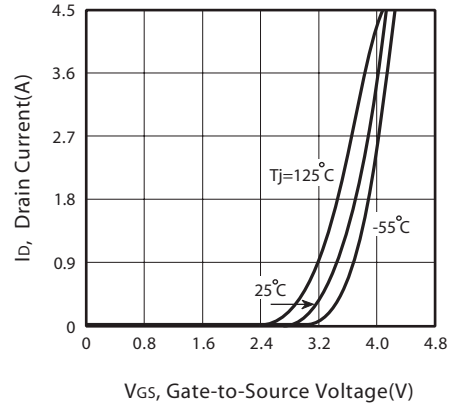

Figure 2. Transfer Characteristics

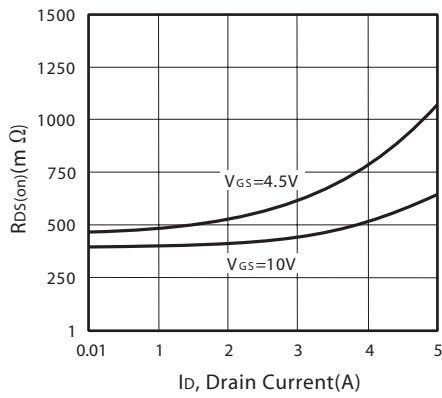

Figure 3. On-Resistance vs. Drain Current and Gate Voltage

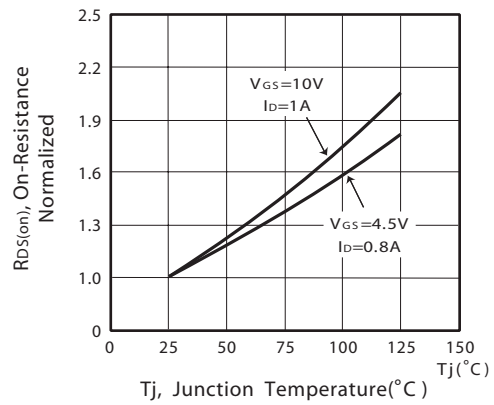

Figure 4. On-Resistance Variation with Drain Current and Temperature

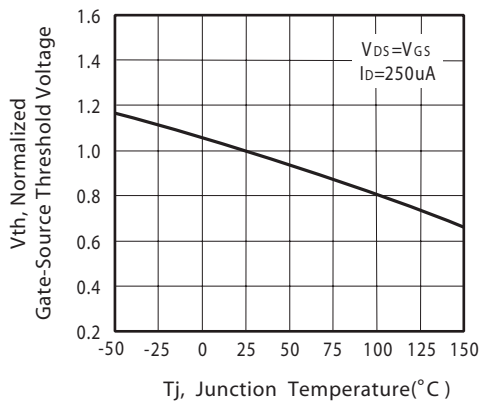

Figure 5. Gate Threshold Variation with Temperature

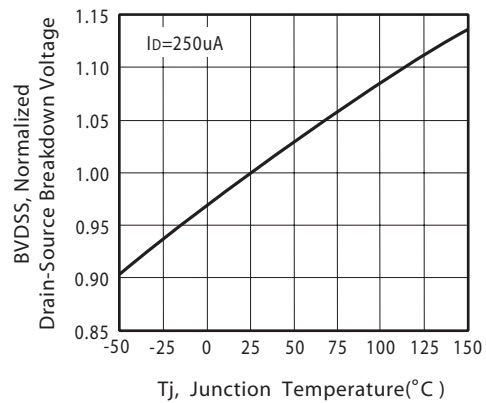

Figure 6. Breakdown Voltage Variation with Temperature

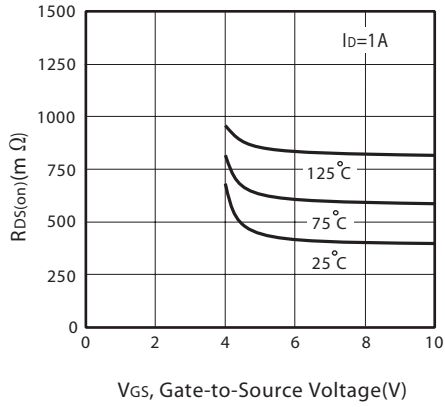

Figure 7. On-Resistance vs. Gate-Source Voltage

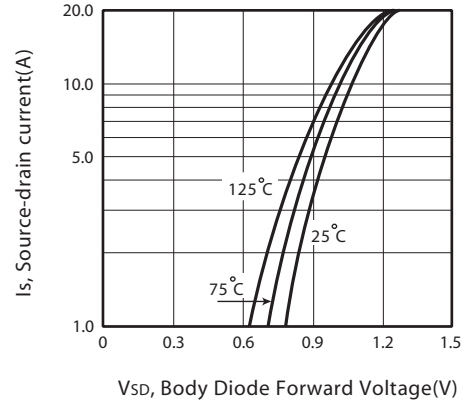

Figure 8. Body Diode Forward Voltage Variation with Source Current

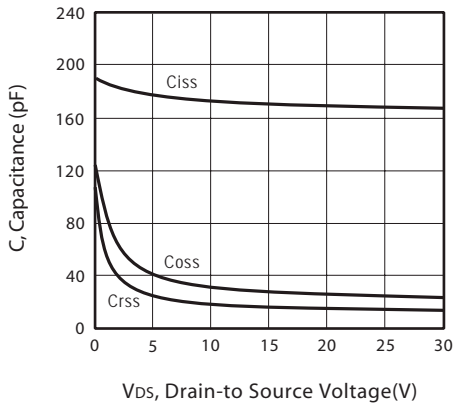

Figure 9. Capacitance

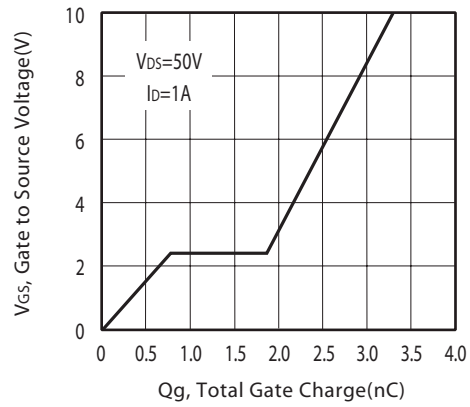

Figure 10. Gate Charge

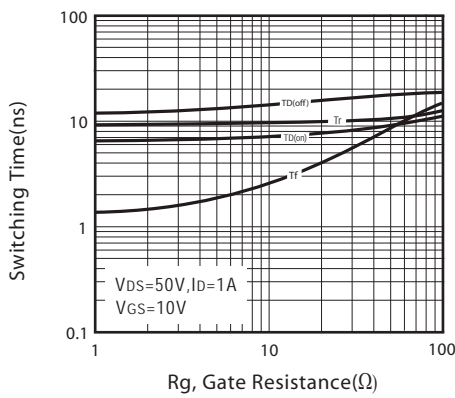

Figure 11. switching characteristics

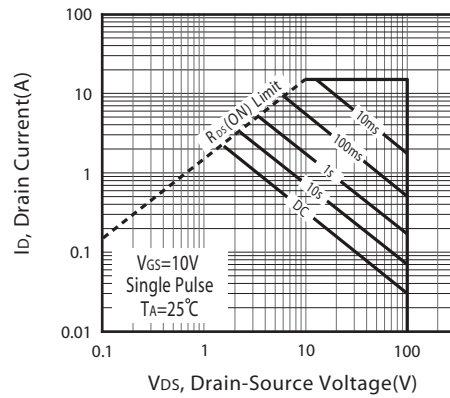
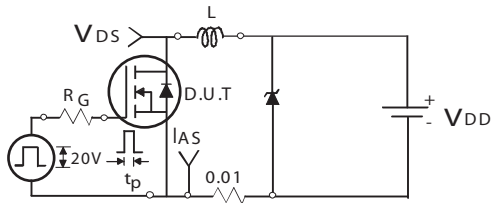
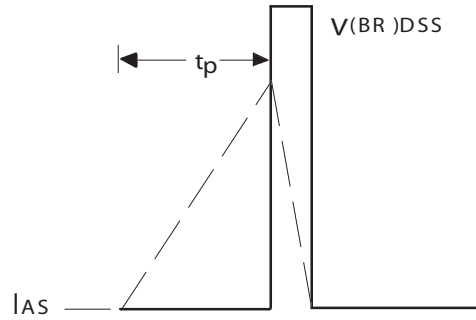

Figure 12. Maximum Safe Operating Area



Unclamped Inductive Test Circuit

Figure 13a.



Unclamped Inductive Waveforms

Figure 13b.

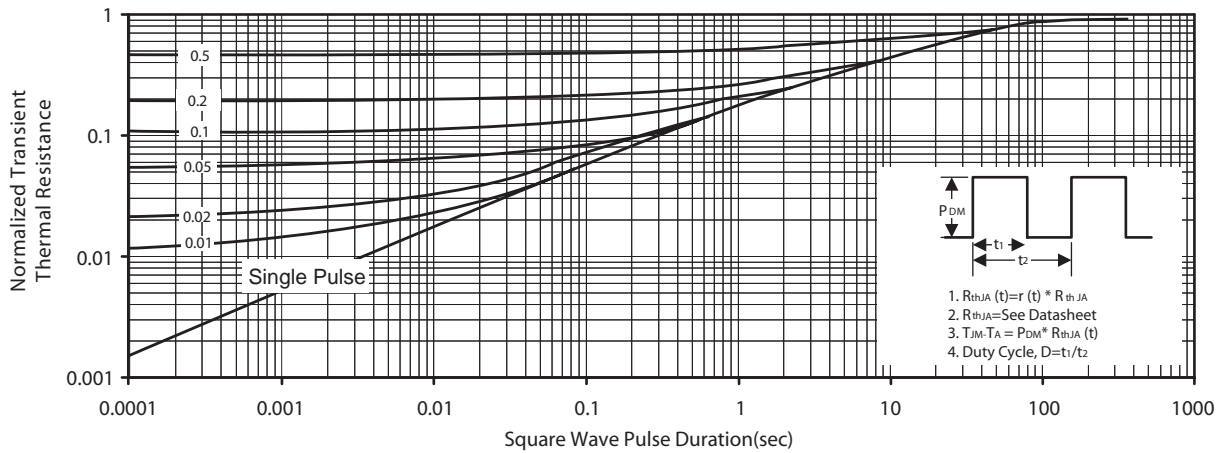
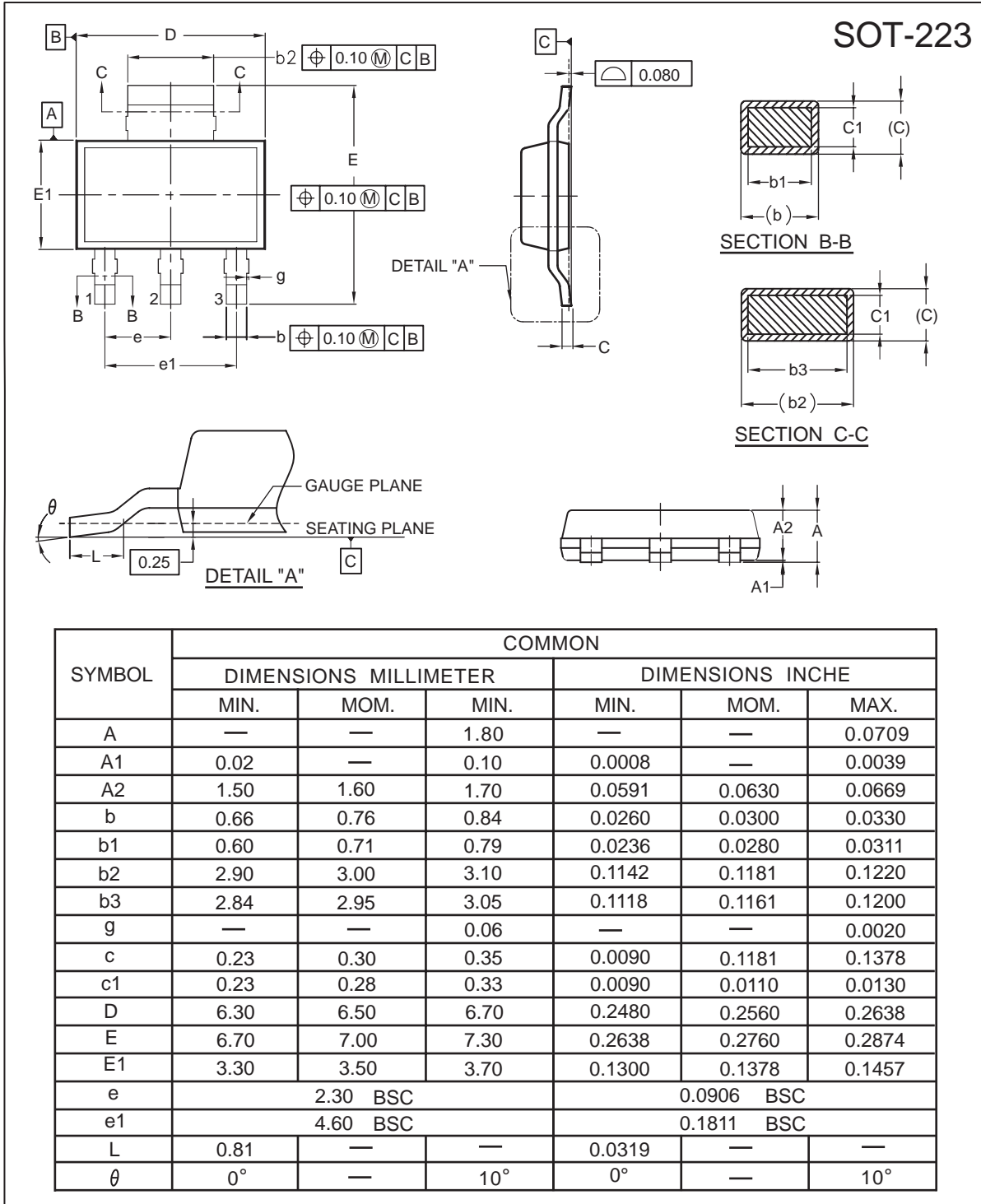

Figure 14. Normalized Thermal Transient Impedance Curve

# STT02N10

Ver 1.0



May,08,2014

## SOT-223 Tape and Reel Data

### SOT-223 Carrier Tape

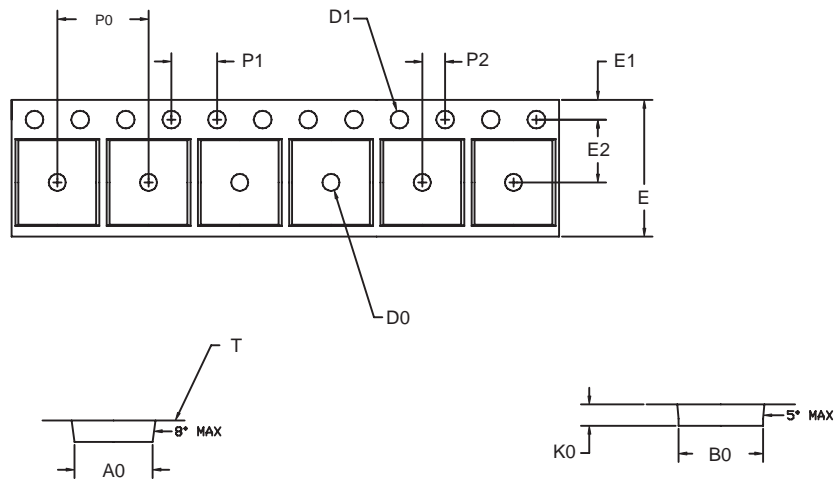

unit:mm

PACKAGE	A0	B0	K0	D0	D1	E	E1	E2	P0	P1	P2	T
---	6.83 ±0.1	7.42 ±0.1	1.88 ±0.1	1.50 +0.25	1.60 +0.1	12.0 +0.3 -0.1	1.75 ±0.1	5.50 ±0.5	8.0 ±0.1	4.00 ±0.1	2.00 ±0.05	0.292 ±0.02

### SOT-223 Reel

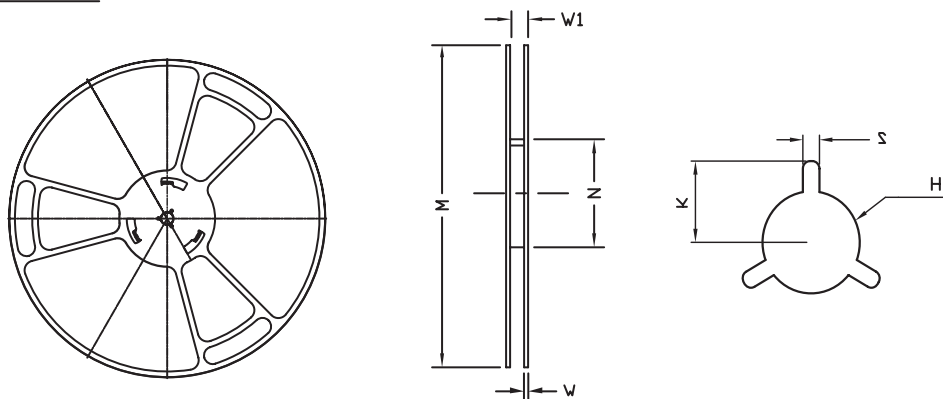

UNIT:mm

REEL SIZE	M	N	W	W1	H	K	S	G	R	V
φ 330 ± 0.5	---	φ 97.0 ± 1.0	2.2	13.0 + 1.5	φ 13.0 + 0.5 - 0.2	10.6	2.0 ± 0.5	---	---	---

# STT02N10

## TOP MARKING DEFINITION

